

FLAT TOP TOWER CRANE

Specifications:

- ▶ Max jib length: 70,00 m
- ▶ Capacity at max length: 2,10 t
- ▶ Max capacity: 12,00 t



T-Link



Zoning

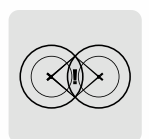

Anticollision

WORKS FOR YOU.™

KEY

Legenda · Zeichenerklärung · Légende · Leyenda · Legenda · Условные обозначения



Hoisting · Sollevamento · Heben · Levage · Elevación · Elevação · Подъем



Trolleying · Traslazione carrello Katzfahren · Distribution · Distribución · Distribuição · Передвижение каретки



Slewing · Rotazione · Schwenken · Orientation · Orientació · Giro · Поворот



Travelling · Traslazione · Schienenfahren · Translation · Traslación · Móvel · Передвижение



Directive on noise level · Direttiva sul livello acustico · Richtlinie für den Schall-Leistungspegel · Directive sur le niveau acoustique · Directiva sobre el nivel acustico · Diretiva sobre nível de ruídos · Директива по уровню шума



Consult us · Consultateci · Auf Anfrage · Nous consulter · Consultarnos · Consulte-nos · Проконсультироваться с нами



Power requirements · Potenza totale richiesta · Geforderte Stromstärke · Puissance totale nécessaire · Potencia necesaria · Requisitos de energia · Требования по питанию



Power supply · Alimentazione · Stromversorgung · Alimentation · Alimentación · Fonte de alimentação · Питание



In service · In servizio · In Betrieb · En service · En servicio · Em serviço · При работе



Out of service · Fuori servizio · Außer Betrieb · Hors service · Fuera de servicio · Fora de serviço · В режиме простоя



Max. under hook height · Altezza max. sotto gancio · Höchste Hakenhöhe · Hauteur maxi. sous crochet · Maxima altura bajo gancho · Alt. máx. sob o gancho · Макс высота крюка



Without load, without ballast, max. jib and max. height · A vuoto, senza zavorra, braccio max., altezza max. · Ohne Last und Ballast, mit Maximalausleger und Maximalhöhe · A vide, sans lest, avec flèche et hauteur maximum · Sin carga, sin lastre, con pluma y altura máxima · Sem carga, sem lastro, lança máxima, altura máxima · Без груза, без балласта, на макс. Длине вспомогательной стрелы и макс. Высоте



Counterweight · Zavorra controbraccio · Gegengewicht · Lest de contre-flèche · Lastre de contra flecha · Contrapeso · Противовес

C25

EN 14439-C25 out of service proof with LC1 & LC3 - wind coming from each side 100 Km/h - For different requirement please contact us · EN 14439 - C25 fuori servizio con LC1 & LC 3 - vento in ogni direzione 100 km/h - contattateci per differenti richieste · EN 14439 - C25 außer Betrieb mit LC1 & LC3 - Wind von jeder Seite 100 km/h - für abweichende Anforderungen kontaktieren Sie uns bitte · EN14439 - C25 hors service avec LC1 & LC3 - vent 100km/h de chaque côté - Nous contacter pour des caractéristiques différentes · EN 14439 - C25 fuera de servicio con LC1 & LC3 - viento de cada lado 100 km/h - contáctenos si necesita más información · EN 14439 - C25 fora de serviço com LC1 e LC3 - vento de cada lado 100 kmh - para pedidos especiais, entre em contato conosco · EN14439 - C25 не совместим с LC1 & LC3 - ветровая нагрузка не более 100км/ч - для уточнения спецификаций обращайтесь, пожалуйста, к нам



TEREX® | **TTC**

CE EN 14439:2009



CONTENTS

СТТ 231-12

Indice · Inhalt · Contenu · Contenido · Sumário · Содержание

Page · Pagina · Seite · Page · Página · Página · Страница:

Load Diagram · Diagramma di portata · Lastkurven · Courbes de charges · Curvas de cargas · Diagrama de carga · Диаграмма грузоподъёмности	4
Tower · Torre · Turm · Tour · Torre · Torre · Башня	6
Mechanisms · Meccanismi · Antriebe · Mécanismes · Mecanismos · Mecanismo · Механизм	10
Transportation · Trasporto · Transport · Transport · Transporte · Transporte · Транспортировка	12

LOAD DIAGRAM

Diagramma di portata · Lastkurven · Courbes de charges · Curvas de cargas · Diagramma di portata · Diagrama de carga · Диаграмма грузоподъёмности

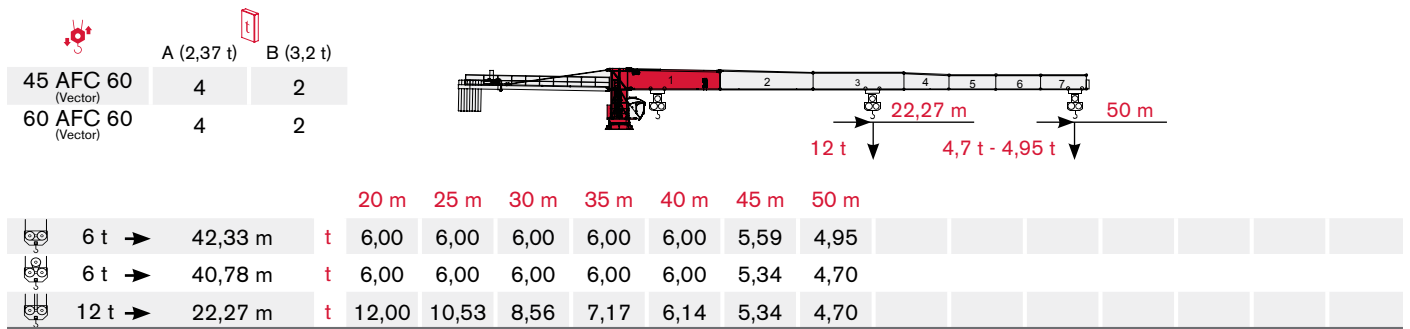
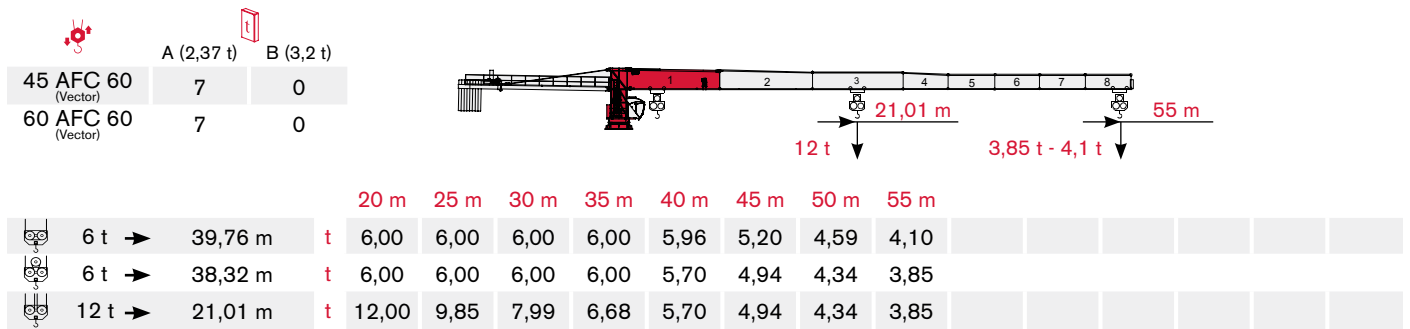
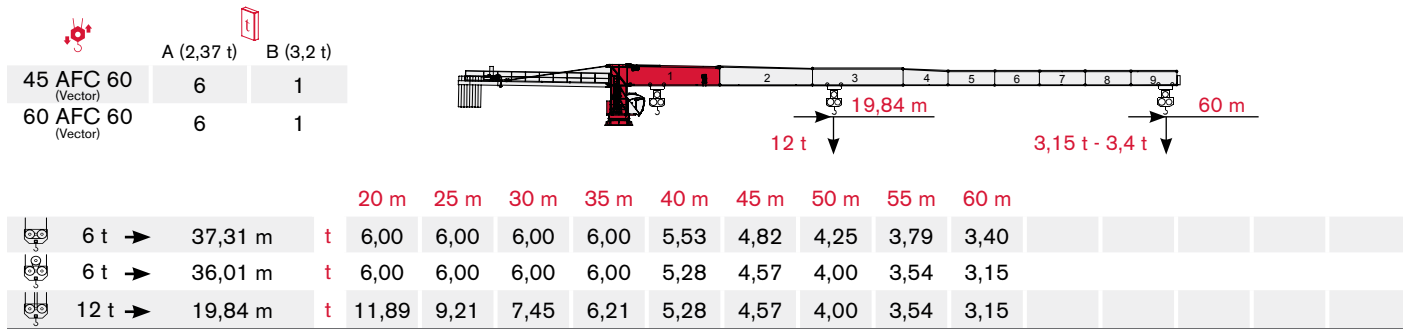
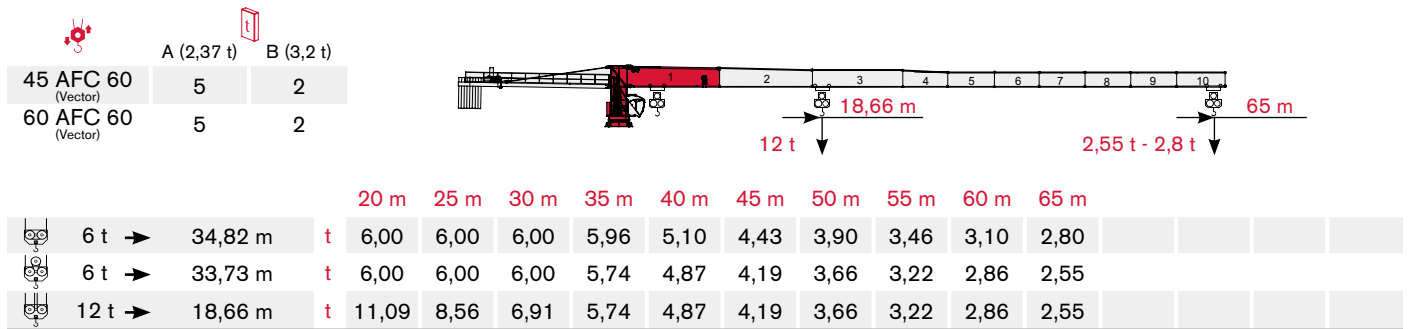
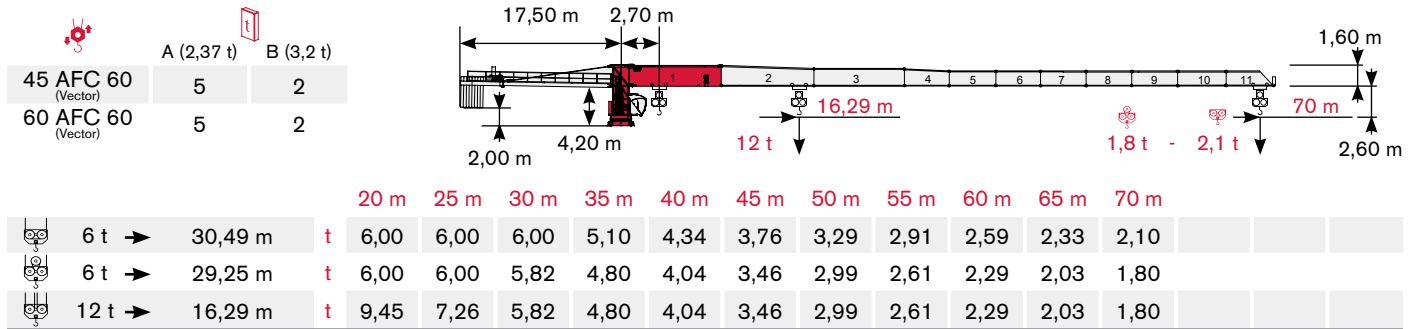

	A (2,37 t)	B (3,2 t)
45 AFC 60 (Vector)	5	1
60 AFC 60 (Vector)	5	1

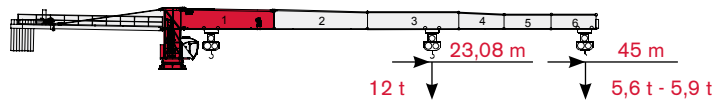

			20 m	25 m	30 m	35 m	40 m	45 m											
6 t →	44,34 m	t	6,00	6,00	6,00	6,00	6,00	5,90											
6 t →	42,43 m	t	6,00	6,00	6,00	6,00	6,00	5,60											
12 t →	23,08 m	t	12,00	10,97	8,94	7,50	6,43	5,60											

	A (2,37 t)	B (3,2 t)
45 AFC 60 (Vector)	6	0
60 AFC 60 (Vector)	6	0

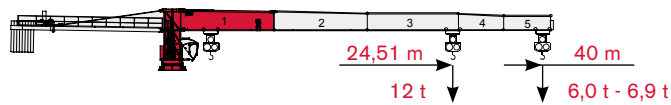

			20 m	25 m	30 m	35 m	40 m												
6 t →	40,00 m	t	6,00	6,00	6,00	6,00	6,00												
6 t →	40,00 m	t	6,00	6,00	6,00	6,00	6,00												
12 t →	24,51 m	t	12,00	11,74	9,57	8,04	6,90												

	A (2,37 t)	B (3,2 t)
45 AFC 60 (Vector)	3	2
60 AFC 60 (Vector)	3	2

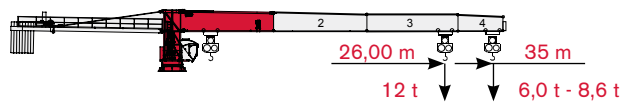

			20 m	25 m	30 m	35 m													
6 t →	35,00 m	t	6,00	6,00	6,00	6,00													
6 t →	35,00 m	t	6,00	6,00	6,00	6,00													
12 t →	26,00 m	t	12,00	12,00	10,23	8,60													

	A (2,37 t)	B (3,2 t)
45 AFC 60 (Vector)	5	0
60 AFC 60 (Vector)	5	0

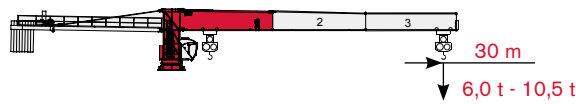

			20 m	25 m	30 m														
6 t →	30,00 m	t	6,00	6,00	6,00														
6 t →	30,00 m	t	6,00	6,00	6,00														
12 t →	26,61 m	t	12,00	12,00	10,50														

TOWER

Torre · Turm · Tour · Torre · Torre · Башня

Standard Configurations · Installazioni Standard · Standardkonfiguration · Standard Implantations · Implantaciones Standard · Configuração padrão · Стандартная конфигурация крана

H20

Tower: H20 & Basement: RTL

	●	◊
R1	-2277 kN	-2836 kN
R2	1704 kN	2374 kN
	924 kN	

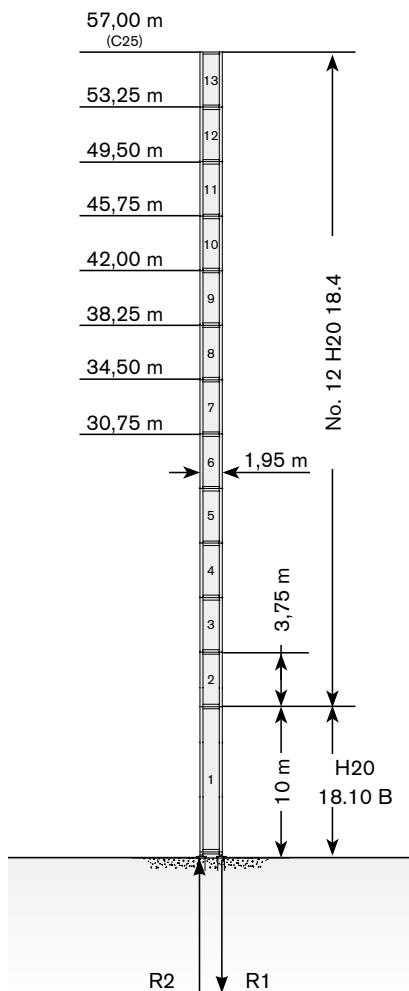

Tower: H20 & Basement: FTR

	●	◊
R1	-1254 kN	-1566 kN
R2	0 kN	0 kN
	1031 kN	

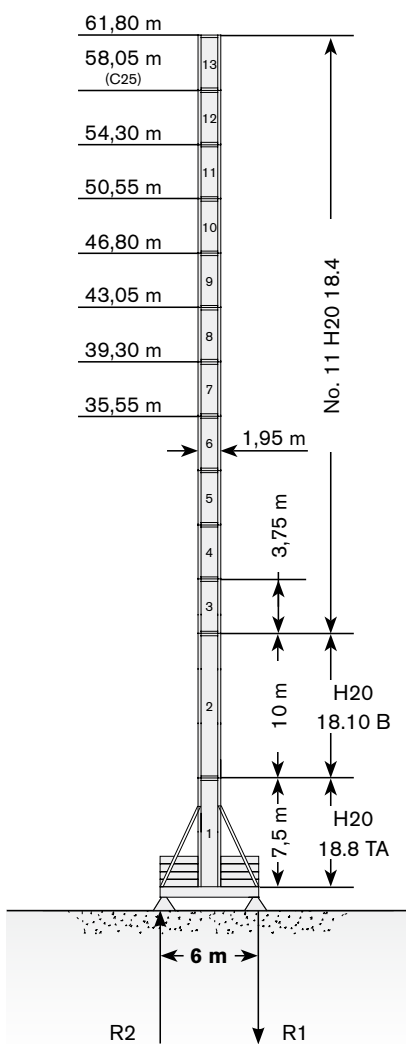

Tower: H20 & Basement: TTR

	●	◊
R1	-1459 kN	-1566 kN
R2	0 kN	0 kN
	1044 kN	

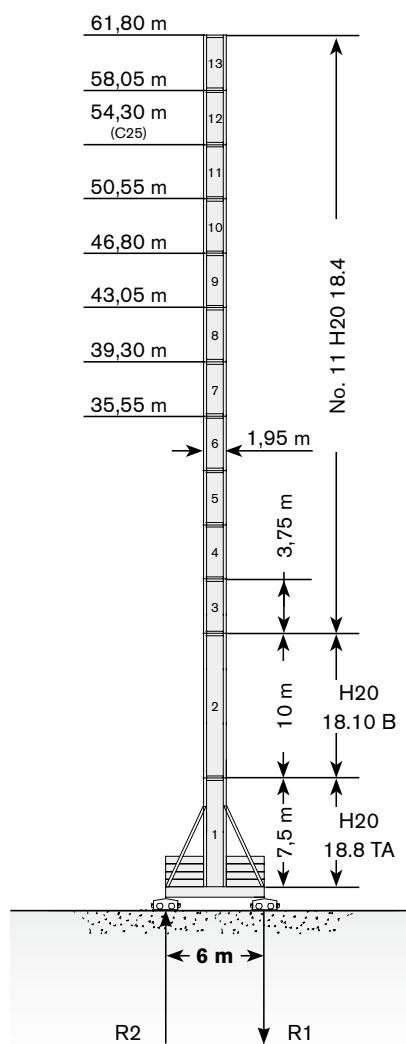

Max. under hook height · Altezza max. sotto gancio · Höchste Hakenhöhe · Hauteur maxi. sous crochet · Maxima altura bajo gancho · alt. máx. sob o gancho · макс высота крюка

Different heights and tower combinations are available; please consult us · Altezze diverse e combinazioni di torre sono disponibili; consultateci · Andere Höhen und Turmkombinationen auf Anfrage · Différentes hauteurs et combinaisons de tour sont disponibles; nous consulter · Hay diferentes alturas y combinaciones de torre disponibles. Consúltenos · Diferentes alturas e combinações de torres disponíveis; fale conosco · Возможны другие сочетания высоты и конфигурации башни; проконсультируйтесь с нами

**Other configurations · Altre Installazioni · Aufstellmöglichkeiten ·
Autres Implantations · Otras Implantaciones · Outras configurações ·
Другие конфигурации**

Bottom climbing crane · Gru climbing · Kletterkran im Gebäude · Télescopage sur dalles · Telescopage grúa trepadora · Guindaste automontante interno · Самоподъемный кран

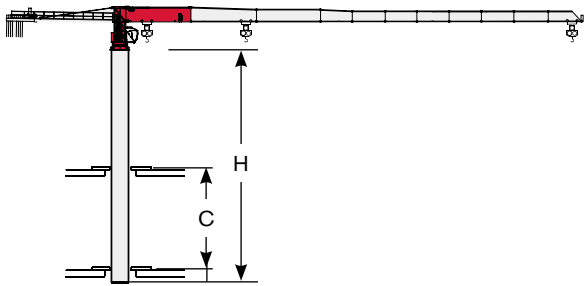

H20	min	max
C	10 m	16 m
H	41,25 m	52,5 m

Crane tied to the structure · Gru ancorata · Geankerter Kran · Grue ancrée · Grúa anclada · Guindaste ancorado na estrutura · Кран, крепящийся к сооружению

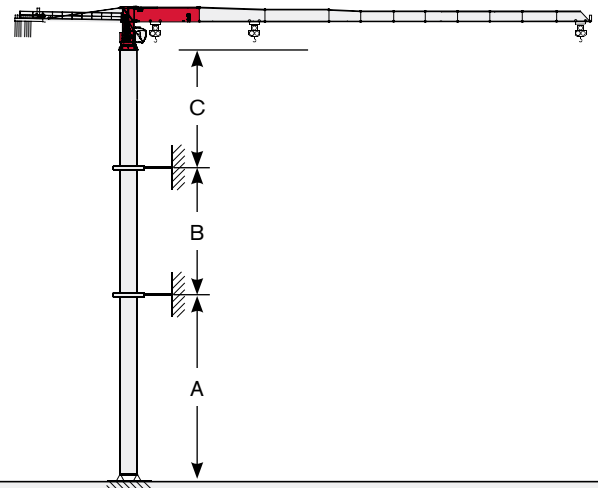

H20	min	max
A	26 m	45 m
B	15 m	22,5 m
C	33 m	



Different heights and tower combinations are available; please consult us • Altezze diverse e combinazioni di torre sono disponibili; consultateci • Andere Höhen und Turmkombinationen auf Anfrage • Différentes hauteurs et combinaisons de tour sont disponibles; nous consulter • Hay diferentes alturas y combinaciones de torre disponibles. Consúltenos • Diferentes alturas e combinações de torres disponíveis; fale conosco • Возможны другие сочетания высоты и конфигурации башни; проконсультируйтесь с нами

TOWER

Torre · Turm · Tour · Torre · Torre · Башня

Standard Configurations · Installazioni Standard · Standardkonfiguration · Standard Implantations · Implantaciones Standard · Configuração padrão · Стандартная конфигурация крана

TS23

Tower: TS23 & Basement: R

	●	◊
R1	-1993 kN	-2580 kN
R2	1465 kN	2161 kN
	837 kN	

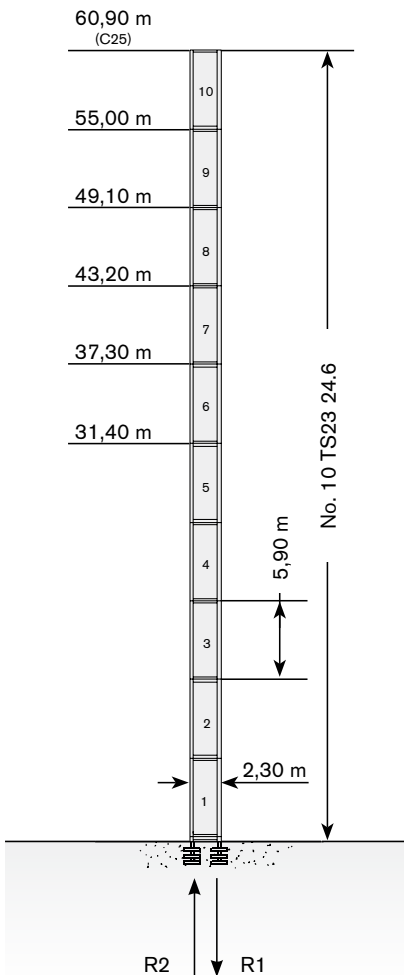

Tower: TS23 & Basement: F

	●	◊
R1	-1280 kN	-1669 kN
R2	0 kN	0 kN
	941 kN	

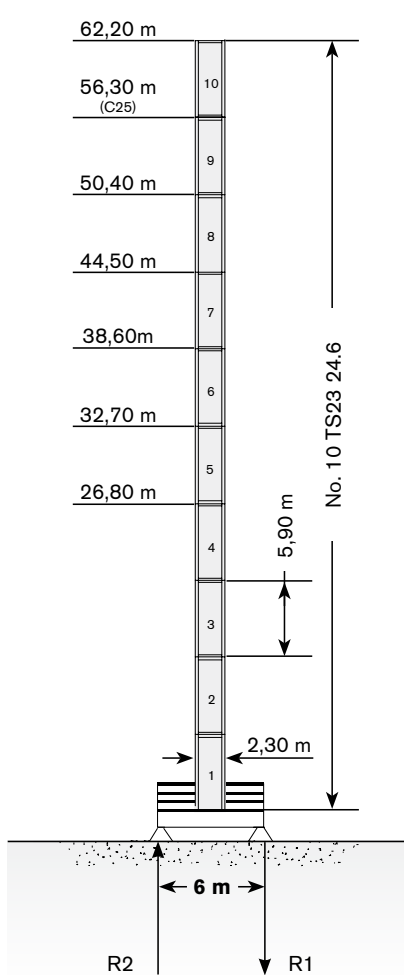

Tower: TS23 & Basement: F1

	●	◊
R1	-1202 kN	-1064 kN
R2	-133 kN	-384 kN
	653 kN	

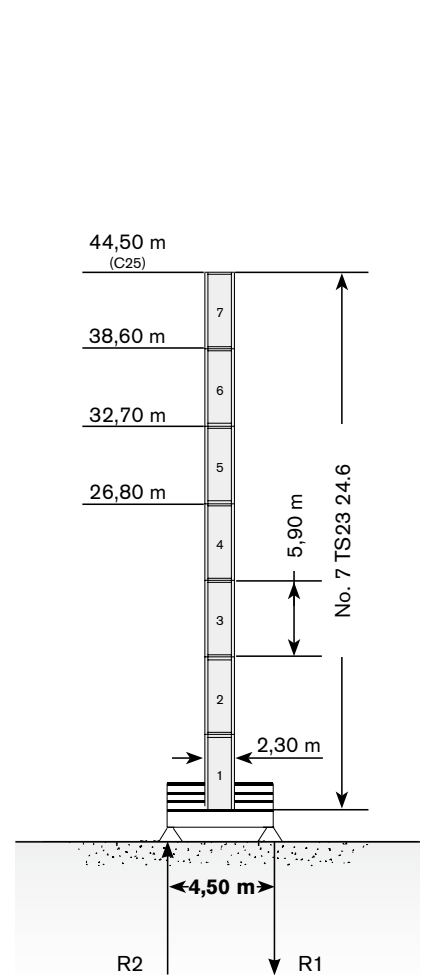

Max. under hook height · Altezza max. sotto gancio · Höchste Hakenhöhe · Hauteur maxi. sous crochet · Maxima altura bajo gancho · Alt. máx. sob o gancho · Макс высота крюка

Tower: TS23 & Basement: T

	●	◊
R1	-1993 kN	-2580 kN
R2	1465 kN	2161 kN
	837 kN	

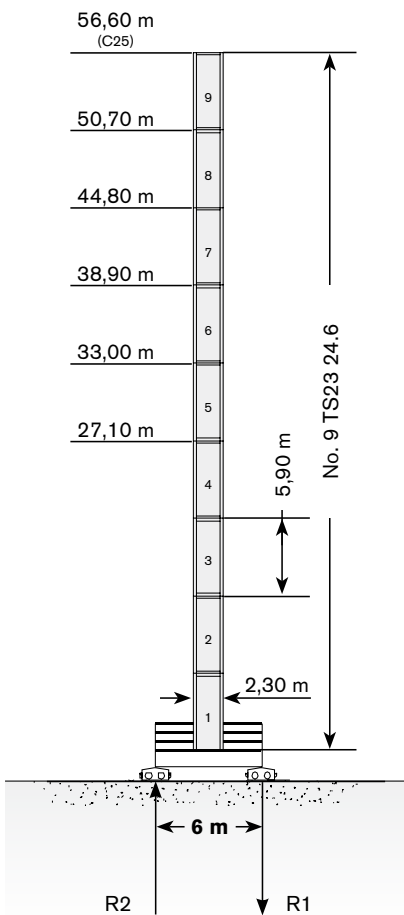

Tower: TS23 & Basement: T1

	●	◊
R1	-1420 kN	-1065 kN
R2	0 kN	0 kN
	686 kN	

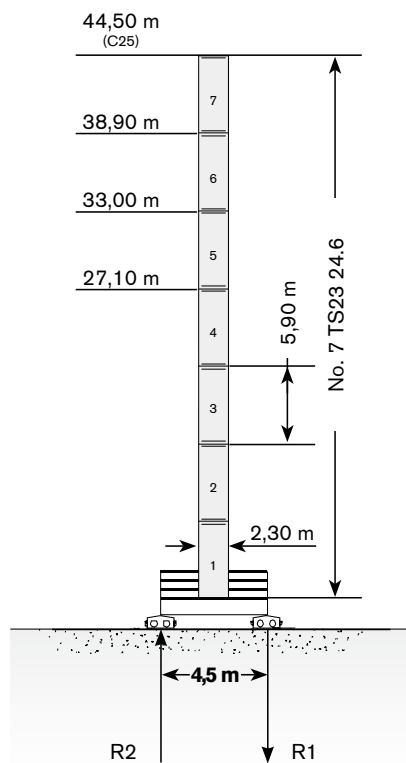

The available lengths for the TS tower sections are 11.8 m, 5.9 m, 2.95 m. · Le prolunghe TS sono disponibili in lunghezze 11.8 m, 5.9 m, 2.95 m. · Die Turmschüsse TS sind mit Längen 11.8 m, 5.9 m, 2.95 m verfügbar. · Les éléments de mât TS sont disponibles en longueur 11.8 m, 5.9 m, 2.95 m. · Los tramos de torre TS son disponibles en las medidas de largo 11.8 m, 5.9 m, 2.95 m. · Os comprimentos disponíveis para elementos de torre TS são: 11.8m, 5.9m e 2.95m. · Длина поставляемых секций башни TS - 11.8 м, 5.9 м, 2.95 м.

TOWER

CTT 231-12

Torre · Turm · Tour · Torre · Torre · Башня

Other configurations · Altre Installazioni · Aufstellmöglichkeiten ·
Autres Implantations · Otras Implantaciones · Outras configurações ·
Другие конфигурации

Crane tied to the structure · Gru ancorata · Geankerter Kran · Grue
ancrée · Grúa anclada · Guindaste ancorado na estrutura · Кран, кре-
пящийся к сооружению

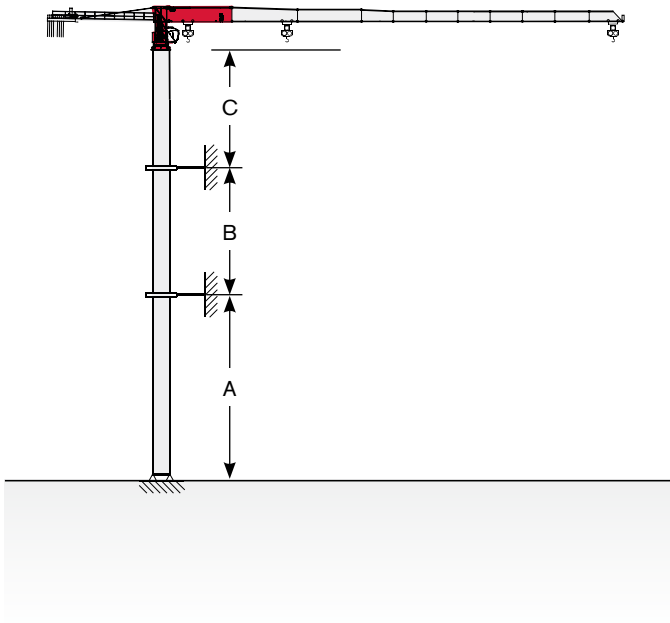

TS23	min	max
A	42 m	47 m
B	25 m	34 m
C	37 m	







Different heights and tower combinations are available; please consult us • Altezze diverse e combinazioni di torre sono disponibili; consultateci • Andere Höhen und Turmkombinationen auf Anfrage • Différentes hauteurs et combinaisons de tour sont disponibles; nous consulter • Hay diferentes alturas y combinaciones de torre disponibles. Consúltenos • Diferentes alturas e combinações de torres disponíveis; fale conosco • Возможны другие сочетания высоты и конфигурации башни; проконсультируйтесь с нами

MECHANISMS

CTT 231-12









Meccanismi · Antriebe · Mécanismes · Mecanismos · Mecanismo · Механизм

Power supply · Alimentazione · Stromversorgung · Alimentation · Suministro eléctrico · Requisitos de energia · Требования по питанию

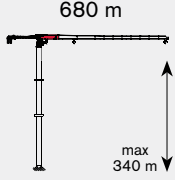
				
	45 AFC 60	93 kVA*	400V - 50Hz / 460V - 60Hz	2000/14/CE modificata
	60 AFC 60	110 kVA*	400V - 50Hz / 460V - 60Hz	2000/14/CE modificata

* Average consumption · Consumo medio · Durchschnittsverbrauch · Consommation moyenne · Consumo medio · Consumo médio · Среднее потребление

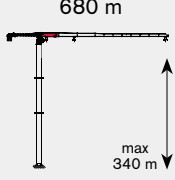
Hoisting · Sollevamento · Heben · Levage · Elevación · Elevação · Подъем

			t	m/min	kW	
	45 AFC 60 (Vector)		6	0 → 35	45	
			4	0 → 49		
			3	0 → 63		
			2	0 → 90		
			1	0 → 127		
			12	0 → 18		
			8	0 → 24		
			6	0 → 32		
			4	0 → 45		
			2	0 → 64		
	60 AFC 60 (Vector)		6	0 → 45	60	
			4	0 → 62		
			3	0 → 80		
			2	0 → 114		
			1	0 → 162		
			12	0 → 22		
			8	0 → 31		
			6	0 → 40		
			4	0 → 57		
			2	0 → 81		

MECHANISMS

Meccanismi · Antriebe · Mécanismes · Mecanismos · Mecanismo · Механизм

Hoisting Speed · Velocità di Sollevamento · Heben Geschwindigkeit · Vitesse de Levage · Velocidad de Elevación · Velocidade de içamento · Скорость подъема

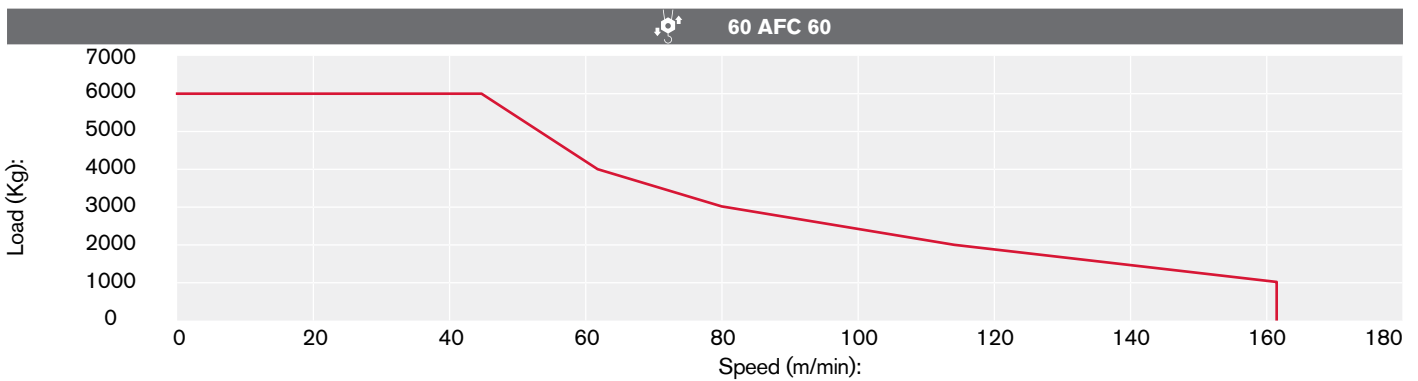
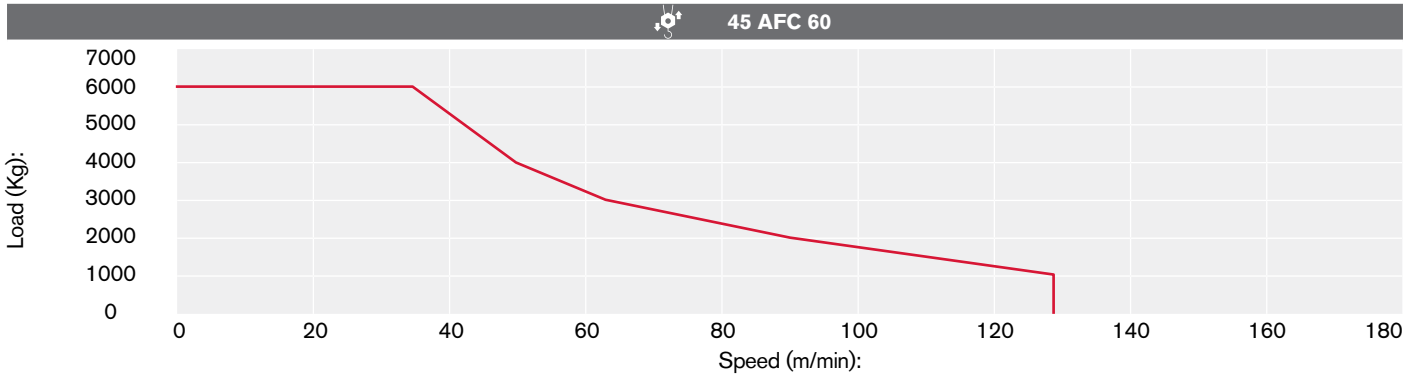











Additional Specifications · Altre movimentazioni · Weitere Leistungsdaten · Spécifications additionnelles · Otras prestaciones · Especificações adicionais · Дополнительные спецификации

	DVF 3 8 D2	0 → 37 → 74 m/min	7,5 kW
	SCC 2 2 112 L	0,88 r.p.m.	2 x 15 kW
	TSR 2RG 4M8	12 → 24 m/min (50 Hz) 14 → 28 m/min (60 Hz)	4 x 80 Nm

Packing list

Undercarriage

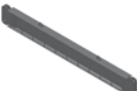
CTT 231-12 H20	DESCRIPTION · DESCRIZIONE · BESCHREIBUNG · DESCRIPTION · DESCRIPCIÓN · DESCRIÇÃO · ОПИСАНИЕ	LENGTH · LUNGHEZZA · LÄNGE · LONGUEUR · LONGITUD · COMPRIMENTO · ДЛИНА	WIDTH · LARGHEZZA · BREITE · LARGEUR · ANCHURA · LARGURA · ШИРИНА	HEIGHT · ALTEZZA · HÖHE · HAUTEUR · ALTURA · ALTURA · ВЫСОТА	QUANTITY · QUANTITÀ · MENGE · QUANTITÉ · CANTIDAD · QUANTIDADE · КОЛИЧЕСТВО	WEIGHT · PESO · GEWICHT · POIDS · PESO · PESO · ВЕС
	6x6 m UNDERCARRIAGE LONG BEAM	8,95 m	0,50 m	1,05 m	1	2088 kg
	6x6 m UNDERCARRIAGE SHORT BEAM	4,40 m	0,50 m	1,05 m	2	1010 kg
	6x6 m UNDERCARRIAGE JOINING SLEEPER	5,50 m	0,15 m	0,48 m	2	280 kg
	6x6 m UNDERCARRIAGE JOINING SLEEPER	5,50 m	0,15 m	0,48 m	2	220 kg
	6x6 m UNDERCARRIAGE STRUT	5,10 m	0,24 m	0,30 m	4	500 kg
CTT 231-12 TS23						
	"A" BEAM FOR 6x6 m TS23 UNDERCARRIAGE	8,89 m	0,85 m	1,24 m	1	4620 kg
	"B" BEAM FOR 6x6 m TS23 UNDERCARRIAGE	8,89 m	0,55 m	1,44 m	1	5010 kg
	CROSSBEAM FOR UNDERCARRIAGE 6x6 m TS23 (Travelling version)	5,41 m	0,45 m	0,18 m	2	440 kg
	"A" BEAM FOR 4.5x4.5 TS23 UNDERCARRIAGE	6,76 m	0,55 m	1,25 m	1	4620 kg
	"B" BEAM FOR 4.5x4.5 TS23 UNDERCARRIAGE	6,76 m	0,55 m	1,44 m	1	4368 kg
	CROSSBEAM FOR UNDERCARRIAGE 4.5x4.5 TS23	3,91 m	0,52 m	0,18 m	2	337 kg

TRANSPORTATION

Trasporto · Transport · Transport · Transporte · Transporte · Транспортировка

Tower









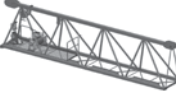

CTT 231-12 H20	DESCRIPTION · DESCRIZIONE · BESCHREIBUNG · DESCRIPTION · DESCRIPCIÓN · DESCRIÇÃO · ОПИСАНИЕ	LENGTH · LUNGHEZZA · LÄNGE · LONGUEUR · LONGITUD · COMPRIMENTO · ДЛИНА	WIDTH · LARGHEZZA · BREITE · LARGEUR · ANCHURA · LARGURA · ШИРИНА	HEIGHT · ALTEZZA · HÖHE · HAUTEUR · ALTURA · ALTURA · · ВИСОТА	QUANTITY · QUANTITÀ · MENGE · QUANTITÉ · · CANTIDAD · QUANTIDADE · КОЛИЧЕСТВО	WEIGHT · PESO · GEWICHT · POIDS · PESO · PESO · ВЕС
	STRUT MOUNTING TOWER ELEMENT H20 18.8TA FOR 6x6 m UNDERCARRIAGE	7,50 m	2,30 m	1,95 m	1	6660 kg*
	H20 18.10 B TOWER ELEMENT	10,00 m	2,00 m	1,95 m	1	7000 kg*
	H20 18.4 S TOWER ELEMENT	3,75 m	2,00 m	1,95 m	1	2955 kg*
	SLEWING UNIT H20	2,30 m	2,30 m	2,50 m	1	7841 kg
CTT 231-12 TS23						
	TS23 24.3 TOWER SECTION	2,95 m	2,33 m	2,25 m	1	2150 kg
	TS23 24.6 TOWER SECTION	5,90 m	2,33 m	2,25 m	1	3700 kg
	SLEWING UNIT TS23	3,00 m	2,30 m	2,10 m	1	7790 kg

* including ladders, platforms, assembly equipment and strut mounting brackets

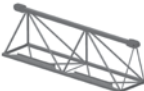
Cab

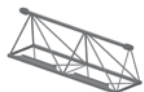

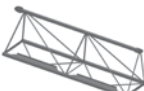





СТТ 231-12	DESCRIPTION · DESCRIZIONE · BESCHREIBUNG · DESCRIPTION · DESCRIPCION · DESCRIÇÃO · ОПИСАНИЕ	LENGTH · LUNGHEZZA · LANGE · LONGUEUR · LONGITUD · COMPRIMENTO · ДЛИНА	WIDTH · LARGHEZZA · BREITE · LARGEUR · ANCHURA · LARGURA · ШИРИНА	HEIGHT · ALTEZZA · HÖHE · HAUTEUR · ALTURA · ALTURA · · ВЫСОТА	QUANTITY · QUANTITÀ · MENGE · QUANTITÉ · · CANTIDAD · QUANTIDADE · КОЛИЧЕСТВО	WEIGHT · PESO · GEWICHT · POIDS · PESO · PESO · ВЕС
	CAB EVO 15	4,60 m	2,40 m	2,20 m	1	1700 Kg
	CAB SECTION 18.05	5,40 m	1,70 m	2,50 m	1	3980 kg

Upper Part

СТТ 231-12						
	JIB SECTION-01 TT15 24.10	10,40 m	1,70 m	2,50 m	1	3595 kg
	JIB SECTION-02 TT15 24.10	10,40 m	1,50 m	2,40 m	1	2270 kg
	JIB SECTION-03 TT15 20.10	10,30 m	1,50 m	2,10 m	1	1735 kg
	JIB SECTION-04 TT15 15.05	5,30 m	1,50 m	2,00 m	1	800 kg
	JIB SECTION-05 TT15 15.05	5,30 m	1,50 m	1,70 m	1	747 kg
	JIB SECTION-06 TT15 15.05	5,20 m	1,50 m	1,70 m	1	575 kg
	JIB SECTION-07 TT15 15.05	5,20 m	1,50 m	1,70 m	1	448 kg
	JIB SECTION-08 TT15 15.05	5,20 m	1,50 m	1,70 m	1	351 kg
	JIB SECTION-09 TT15 15.05	5,10 m	1,50 m	1,70 m	1	318 kg
	JIB SECTION-10 TT15 15.05	5,10 m	1,50 m	1,60 m	1	272 kg

TRANSPORTATION

Trasporto · Transport · Transport · Transporte · Transporte · Транспортировка

СТТ 231-12	DESCRIPTION · DESCRIZIONE · BESCHREIBUNG · DESCRIPTION · DESCRIPCION · DESCRICÃO · ОПИСАНИЕ	LENGTH · LUNGHEZZA · LÄNGE · LONGUEUR · LONGITUD · COMPRIMENTO · ДЛИНА	WIDTH · LARGHEZZA · BREITE · LARGEUR · ANCHURA · LARGURA · ШИРИНА	HEIGHT · ALTEZZA · HÖHE · HAUTEUR · ALTURA · ALTURA · ВЫСОТА	QUANTITY · QUANTITÀ · MENGE · QUANTITÉ · CANTIDAD · QUANTIDADE · КОЛИЧЕСТВО	WEIGHT · PESO · GEWICHT · POIDS · PESO · PESO · ВЕС
	JIB SECTION-11 TT15 15.05	5,10 m	1,50 m	1,60 m	1	238 kg
	JIB POINT TT15 10-12 t	1,70 m	0,90 m	1,60 m	1	140 kg
	TROLLEY TT15 10-12 t	2,20 m	1,80 m	1,20 m	1	474 kg
	TT15 HOIST WINCH UNIT For 30 to 50 m jib	1,20 m	0,50 m	1,70 m	1	400 kg
	COUNTERJIB 1A	11,90 m	1,70 m	1,00 m	1	3932 kg
	COUNTERJIB WINCH 45 AFC 60	5,10 m	2,00 m	2,10 m	1	4340 kg**
	COUNTERJIB WINCH 60 AFC 60	5,20 m	2,00 m	2,40 m	1	4460 kg**
	COUNTERJIB PLATFORMS UNIT	4,50 m	0,70 m	0,40 m	4	870 kg

** HOISTING ROPE NOT INCLUDED

NOTES

CTT 231-12

Appunti · Notizen · Note · Apunte · Notas · Заметки

TEREX TOWER CRANES

Gru Comedil Srl

Via delle Innovazioni, 17
33074 Fontanafredda (PN)
Italy
Ph: +39 0434 989111
Email: mktg.cranes@terex.com

September 2022. Product specifications and prices are subject to change without notice or obligation. The photographs and/or drawings in this document are for illustrative purposes only. Refer to the appropriate Operator's Manual for instructions on the proper use of this equipment. Failure to follow the corresponding Operator's Manual when using our equipment or to otherwise act responsibly may result in serious injury or death. The only warranty applicable to our equipment is the standard written warranty applicable to the particular product and sale and Terex makes no other warranty, express or implied. Products and services listed may be trademarks, service marks or trade-names of Terex Corporation and/or its subsidiaries in the USA and other countries. All rights are reserved. Terex, the Terex Crown design and Works For You are trademarks of Terex Corporation or its subsidiaries.

Settembre 2022. Specifiche e prezzi dei prodotti sono soggetti a modifica senza preavviso o altro obbligo. Le fotografie e i disegni in questo documento hanno esclusivamente scopo illustrativo. Consulta il Manuale dell'operatore pertinente per trovare istruzioni per l'utilizzo corretto di questo macchinario. La mancata osservanza delle istruzioni contenute nel relativo Manuale dell'operatore durante l'uso del macchinario e altri comportamenti irresponsabili possono provocare gravi lesioni, anche mortali. L'unica garanzia applicabile ai nostri macchinari è la garanzia scritta standard applicabile al particolare prodotto e alla particolare vendita e Terex è esonerata dal fornire qualsiasi altra garanzia, esplicita o implicita. I prodotti e servizi elencati possono essere dei marchi di fabbrica, marchi di servizio o nomi commerciali di Terex Corporation, e/o delle rispettive società affiliate negli Stati Uniti d'America e in molte altre nazioni. Tutti i diritti riservati. Terex, il marchio Terex Crown e Works for You sono marchi di proprietà di Terex Corporation o delle sue società affiliate.

September 2022. Irrtum und Änderungen der Produktspezifikationen vorbehalten. Die in diesem Dokument enthaltenen Fotos und/oder Zeichnungen dienen rein anschaulichen Zwecken. Für den sachgemäßen Gebrauch der Maschinen ist das entsprechende Bedienerhandbuch heranzuziehen. Unsachgemäßer Umgang mit bzw. unsachgemäßer Einsatz unserer Maschinen kann zu schweren gesundheitlichen Schäden bis hin zum Tod führen. Für unsere Produkte wird ausschließlich die entsprechende, schriftlich niedergelegte Standardgarantie gewährt. Terex leistet keinerlei darüber hinausgehende Garantie, weder ausdrücklich noch stillschweigend. Die genannten Produkte und Dienstleistungen sind in den USA und anderen Ländern ggf. Marken, Dienstleistungsmarken oder Handelsnamen der Terex Corporation und/oder ihrer Tochtergesellschaften. Alle Rechte vorbehalten. Terex, das Terex Kronenlogo und Works For You sind Marken in Eigentum der Terex Corporation bzw. ihrer Tochtergesellschaften.

Septembre 2022. Les caractéristiques et prix des produits peuvent faire l'objet de modifications sans notification préalable. Les photographies ou dessins présentés dans ce document servent uniquement à des fins d'illustration. Pour connaître les instructions relatives à l'utilisation correcte de cet équipement, veuillez vous référer au manuel de l'utilisateur correspondant. Le non-respect du manuel d'utilisateur correspondant lors de l'utilisation de notre équipement ou des actes irresponsables risquent de provoquer de graves blessures, voire un décès. La seule garantie applicable à nos équipements est la garantie écrite standard applicable au produit et à la vente spécifiques. Terex ne délivre aucune autre garantie, expresse ou implicite. Les produits et les services mentionnés peuvent être des marques, des marques de service ou des appellations commerciales de Terex Corporation et/ou de ses filiales aux États-Unis et dans d'autres pays. Tous droits réservés. Terex, le design Terex Crown et Works For You sont des marques déposées de Terex Corporation ou de ses filiales.

Septiembre 2022. Las especificaciones y los precios de los productos están sujetos a cambios sin necesidad de previo aviso ni ninguna otra obligación. Las fotografías y/o dibujos de este documento tienen un fin meramente ilustrativo. Consulte el correspondiente manual de instrucciones del operario para obtener más información sobre el uso correcto de esta maquinaria. No respetar el manual del operario al utilizar la maquinaria o actuar de forma irresponsable puede provocar lesiones graves e incluso mortales. La única garantía aplicable a nuestra maquinaria es la garantía escrita estándar de cada producto y venta. Terex no amplía dicha garantía de forma expresa ni implícita. Los productos y servicios mencionados pueden ser marcas comerciales, marcas de servicio o nombres de marca de Terex Corporation o de alguna de sus filiales en Estados Unidos y otros países. Todos los derechos reservados. Terex, el diseño de la corona Terex y Works For You son marcas registradas de Terex Corporation o de sus filiales.

Setembro 2022. Especificações e preços dos produtos sujeitos a alteração sem aviso prévio ou obrigações. As fotografias e/ou desenhos neste documento são apenas para fins ilustrativos. Consulte o respectivo Manual do Operador para instruções sobre o uso correto deste equipamento. Deixar de acompanhar o respectivo Manual do Operador ao usar o nosso equipamento ou, por qualquer outra forma, deixar de agir de maneira responsável pode resultar em lesões corporais graves ou a morte. A única garantia aplicável ao nosso equipamento é a garantia padrão por escrito correspondente ao produto específico vendido. A Terex não dá outras garantias, expressas ou implícitas. Os produtos e serviços listados podem ser marcas comerciais, marcas de serviço ou nomes-fantasia da Terex Corporation e/ou suas subsidiárias nos EUA e em outros países. Todos os direitos reservados. Terex, o desenho da Coroa Terex e a expressão Works For You são marcas comerciais da Terex Corporation ou suas subsidiárias.

Сентябрь 2022 г. года Технические характеристики и цены могут изменяться без предварительного уведомления и без каких-либо обязательств для производителя. Фотографии и (или) чертежи в настоящем документе служат только в качестве иллюстраций. Инструкции по надлежащей эксплуатации данного оборудования см. в соответствующем руководстве для оператора. Невыполнение указаний соответствующих руководств для оператора при эксплуатации оборудования или другие безответственные действия могут повлечь серьезные травмы или смерть. Единственной гарантией, действующей в отношении нашего оборудования, является стандартная форма письменной гарантии на данный тип оборудования и на условия его продажи. Terex не дает никаких других гарантий: ни ясно выраженных, ни подразумеваемых. Перечисленные продукты и услуги могут быть торговыми марками, знаками обслуживания или торговыми наименованиями Terex Corporation и / или ее дочерних компаний в США и других странах. Все права защищены. Terex, изображение короны Terex и Works for You являются торговыми марками, принадлежащими корпорации Terex или ее дочерним компаниям.

Brochure Reference: TC-DS-M-E//G/F/S/P/R-CTT231-12-09/22



WORKS FOR YOU.™