

MONTHS WARRANTY  
**24**  
MONTHS WARRANTY

# 6.51

# RTH



**MAGNI**  
TELESCOPIC HANDLERS

#### MAIN SECTORS



INDUSTRY



CONSTRUCTION



FEATURED  
PROJECTS

Maximum lifting height: 51.00 m  
Maximum reach: 34.50m  
Electronically controlled  
hydrostatic transmission  
Automatic levelling device  
Scissors stabilizers

MACHINE MODEL	Rotary telescopic handler	RTH 6.51		
	Maximum lifting capacity	6,000 kg (centre of gravity 600 mm)		
	Maximum lifting height	51.00 m		
	Rotation	360° (continuous)		
ENGINE	Type	<b>Volvo TAD 583 VE Stage V</b>	<b>Volvo TAD 572 VE Stage IV</b>	<b>Volvo TAD 552 VE Stage IIIA</b>
	Rated Power	175 kW (238 hp) @ 2,300 rpm	160 kW (218 hp) @ 2,300 rpm	160 kW (218 hp) @ 2,200 rpm
	Maximum torque	975 Nm @ 1,380 rpm	925 Nm @ 1,380 rpm	900 Nm @ 1,500 rpm
	Displacement	5,13 l		
	Cylinders	4 in line		
	Engine configuration	Turbocharged direct injection diesel		
	Cooling System	Water – intercooler		
TRANSMISSION	Type	Hydrostatic		
	Model	Danfoss		
	Maximum pressure	480 bar		
	Displacement	Electronically controlled variable displacement pump Variable displacement motor		
	Gearbox	Dropbox, 2 speeds forward-reverse		
AXLES AND BRAKES	Type	Axles with planetary gearboxes		
	Rear axle	Oscillating and steering with hydraulic locking		
	Front axle	Oscillating and steering with levelling +/-8°		
	Service brake	Hydraulically operated wet multi-disk brakes on each axle		
	Parking brake	Hydraulic with negative action		
	Tyre sizes	17.5 R 25		
PERFORMANCE	Max. travel speed	25 km/h		
	Drawbar pull	199 kN		
	Gradeability	55%		
	Turning circle (at forks)	8,110 mm		
WEIGHTS	Total unladen	36,400 kg		
	Front axle unladen (boom retracted and lowered)	16,000 kg		
	Rear axle unladen (boom retracted and lowered)	20,400 kg		
TANK AND SYSTEM CAPACITIES	Diesel fuel tank	235 l	235 l	235 l
	AdBlue	40 l	40 l	-
	Hydraulic fluid	300 l	300 l	300 l
	Engine oil	16 l	16 l	16 l
	Cooling liquid	40 l	40 l	40 l
HYDRAULIC CIRCUIT FOR MOVEMENTS	Max. working pressure	350 bar		
	Circuit type	Load sensing		
	Service pump	Danfoss – Variable displacement		
	Distributor for boom and turret movements	Danfoss – SIL 2 electro-proportional valve		
	Distributor for stabilisers	Bosch Rexroth – Electro-hydraulic actuators		
	Movements control	2 no. two-axis Danfoss joysticks with deadman safety device Managed via CAN bus		
STANDARDS MET	EN 1459-2: concerning standards for slewing variable-reach trucks EN 13000: concerning standards for mobile cranes EN 280: concerning standards for mobile elevating work platforms FOPS/ROPS EU 2016/1628: concerning engine emissions standards			

The data in this brochure are informative and subject to change without notice

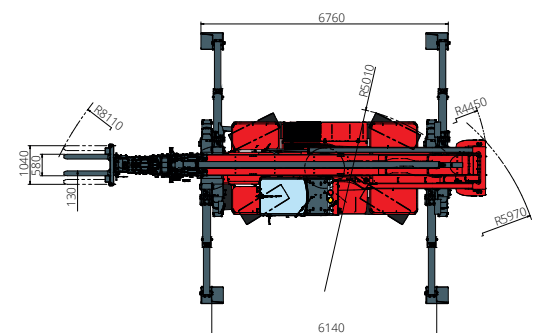
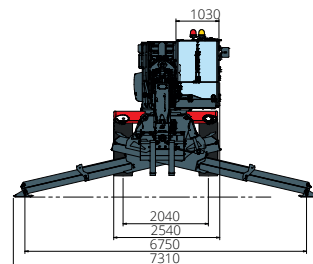
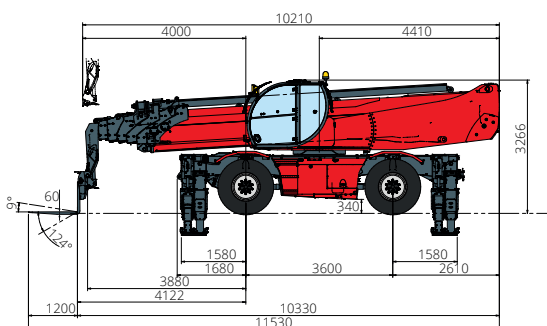

# ON STABILISERS

## 360° LOAD CHART ON FULLY EXTENDED STABILISERS

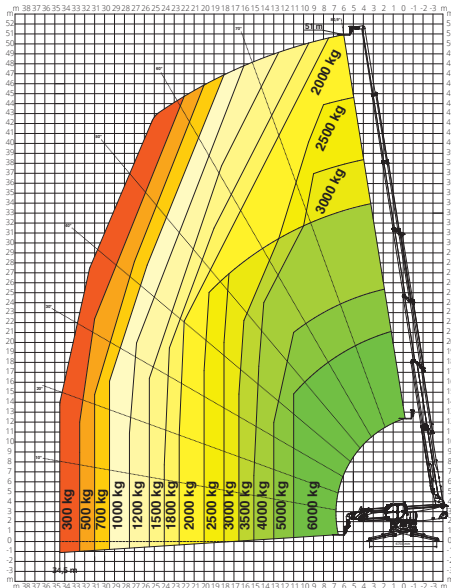

# ON TYRES

## FRONTAL LOAD CHART ON TYRES

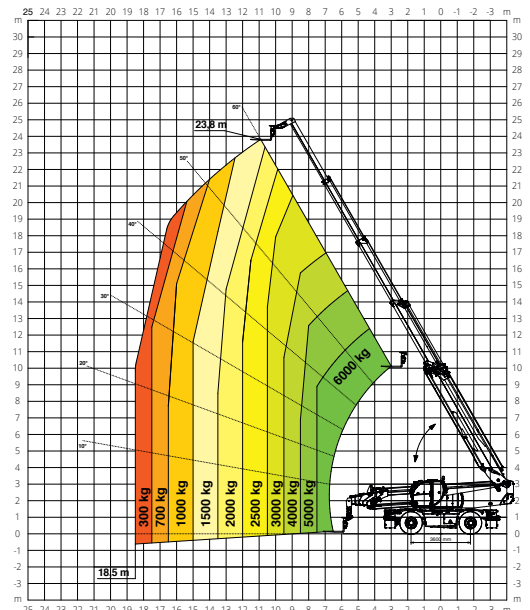

# H 6

## HOOK 6.000 kg

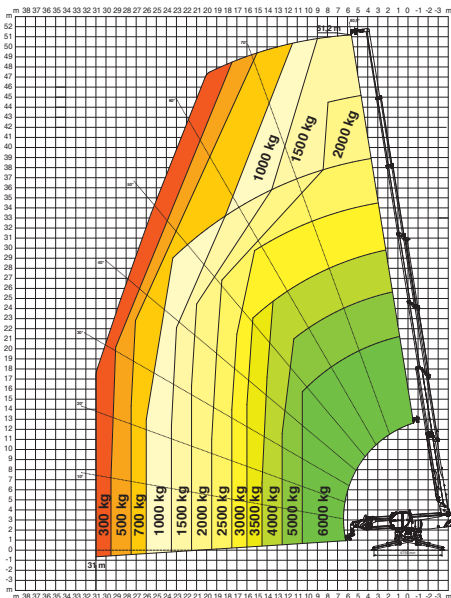

# J2000

## JIB 2.000 kg

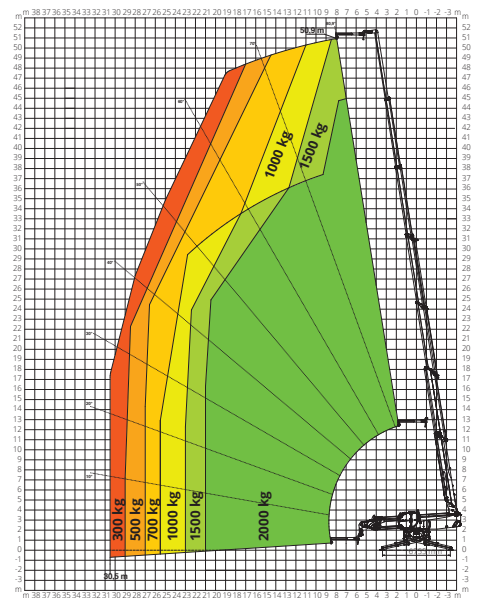

# JW2700

## JIB WITH WINCH 2,700 kg

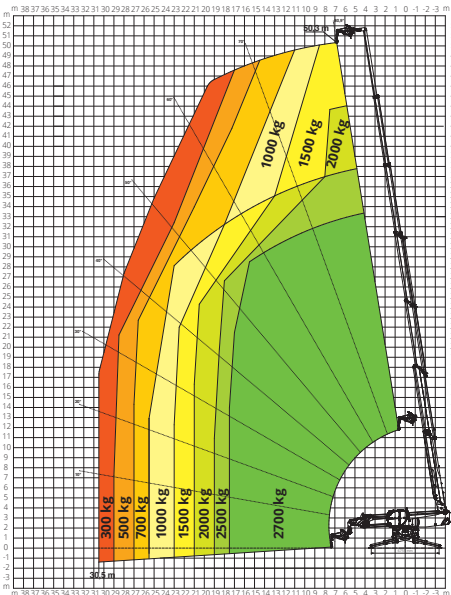

# JW3000

## JIB WITH WINCH 3,000 kg

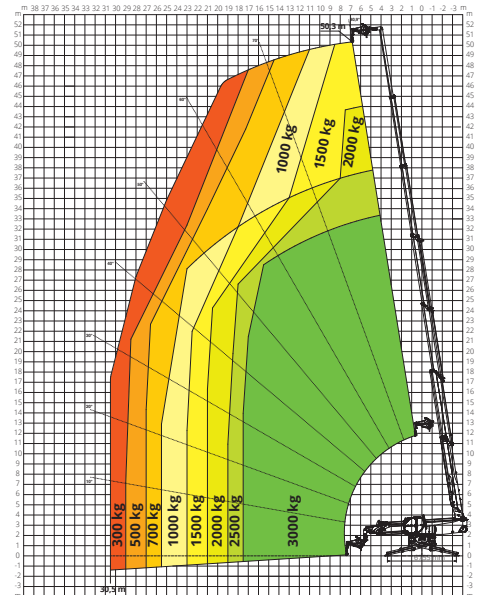

RFC2,5

ROTATING FORKCARRIAGE **2,500 kg**

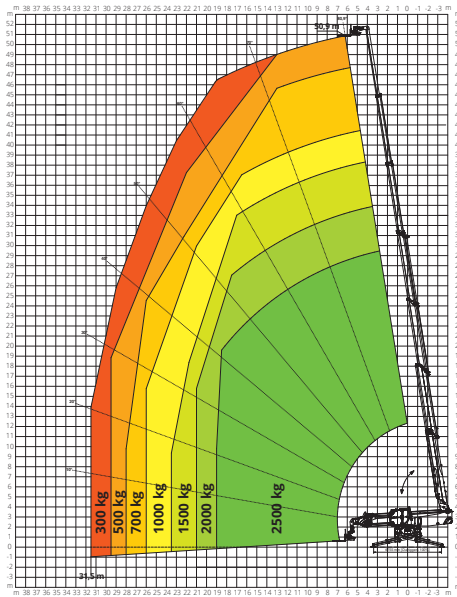

W 2,7

WINCH **2,700 kg**

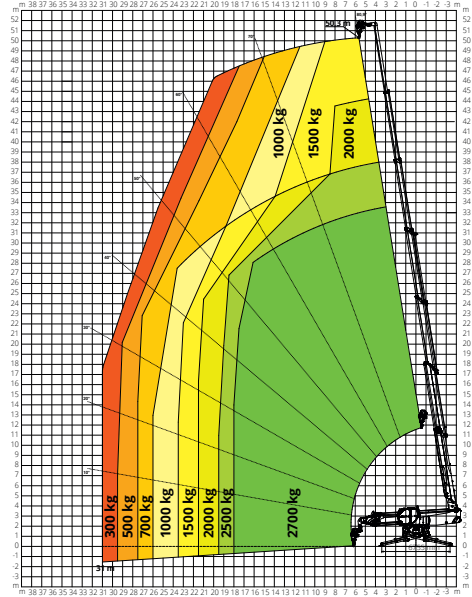

W 3,5

WINCH **3,500 kg**

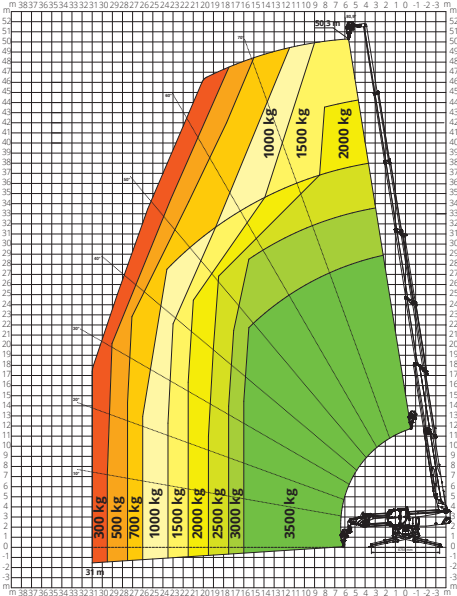

W 6

WINCH **6,000 kg**

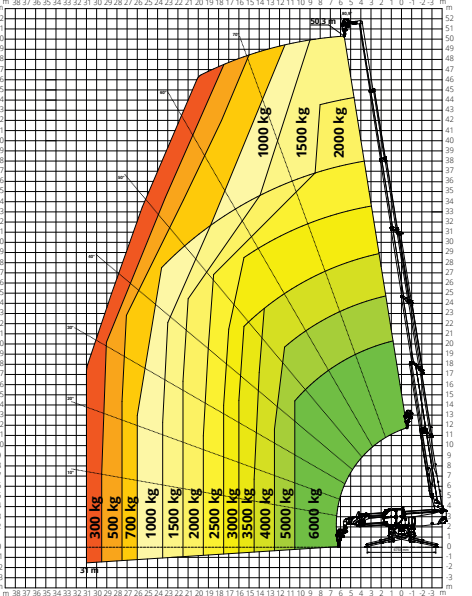

REP 2-4,5

ROTATING EXTENDABLE BASKET **500 kg**

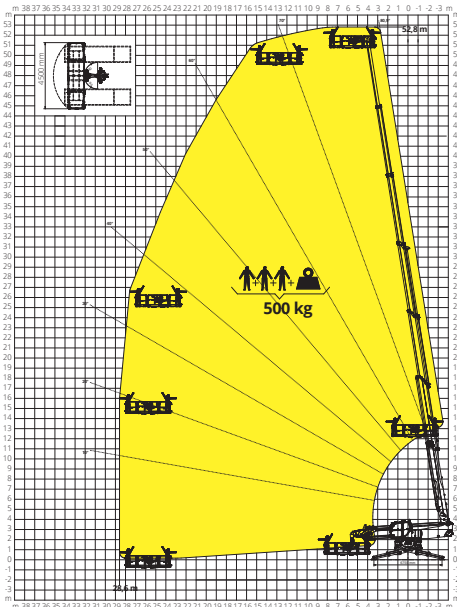

REP 10.2-4,7

ROTATING EXTENDABLE BASKET **1,000 kg**

